





















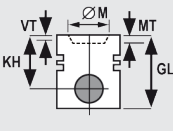



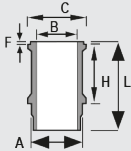
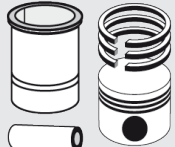



Globally reliable









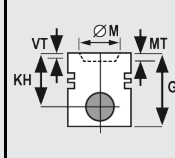

# NEWSLETTER P2/6



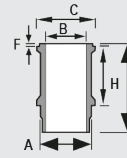
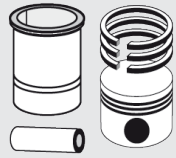

















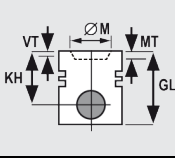

	ccm 								Info	Pos.
UGJC	1499 4	55 KW 75 PS	B-MAX 1.5 TDCi FIESTA VI 1.5 TDCi	10/12 - 09/12 -	73,50	71 2108 0000 5000	4 4	STD 0,50		1

							
<b>1</b>	<b>73,50 mm</b>						
		KH 41,70 MT -13,40 MØ 45,00 GL 65,20	KKK RTK	L 59,00 Ø 26,00	 2,00 913 CDS 1,95 931 P 2,00 947 EX CR		
		<b>71 2108 0000</b> <b>5000</b>			89 2108 0000		

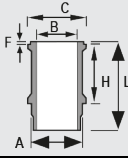
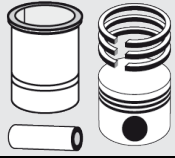
	ccm 								Info	Pos.	
G4ED	1599	4	82 KW 112 PS	ACCENT III 1.6 GLS	11/05 - 11/10	76,50	71 2477 0000 5000	4 4	STD 0,50	For OE No. 23410-26500	1
G4FC	1591	4	88-95 KW 120-129 PS	ELANTRA 1.6 i30 1.6 VELOSTER 1.6	01/16 - 10/07 - 10/11 -	77,00	71 2409 0000 5000	4 4	STD 0,50	For OE No. 23041-2B900	2
G4FJ	1591	4	130-150 KW 177-204 PS	i30 1.6 T-GDI TUCSON 1.6 T-GDi VELOSTER 1.6 T-GDI	01/15 - 06/15 - 08/12 -	77,00	71 2410 0000 5000	4 4	STD 0,50	For OE No. 23041-2B600	3

							
<b>1</b>	<b>76,50 mm</b>						
		KH 28,20 VT1 -0,50 VT2 -0,50 MT -3,50 GL 50,20	LOX	L 47,00 Ø 18,00		1,20 910 IF CR S 1,20 931 FE 2,00 777 CR S	
		<b>71 2477 0000</b> <b>5000</b>	For OE No. 23410-26500			79 2477 0000	
<b>2</b>	<b>77,00 mm</b>						
		KH 26,80 GL 45,00	LOX	L 52,50 Ø 18,00		1,20 910 IF NIT S 1,20 931 P 2,00 947 EX NIT S	
		<b>71 2409 0000</b> <b>5000</b>	For OE No. 23041-2B900			79 2409 0000	
<b>3</b>	<b>77,00 mm</b>						
		KH 26,80 BÜ 3,00 GL 48,00	LOX	L 52,50 Ø 18,00		1,20 910 IF NIT S 1,20 931 P 2,00 947 EX NIT S	
		<b>71 2410 0000</b> <b>5000</b>	For OE No. 23041-2B600			79 2409 0000	

	ccm 								Info	Pos.	
G4ED	1599	4	77-82 KW 105-112 PS	CERATO 1.6 16V RIO II 1.6 16V	04/04 - 03/05 -	76,50	71 2477 0000 5000	4 4	STD 0,50	For OE No. 23410-26500	1
G4FC	1591	4	77-96 KW 105-131 PS	CEE'D 1.6 CVVT SOUL 1.6 CVVT	05/12 - 02/09 -	77,00	71 2409 0000 5000	4 4	STD 0,50	For OE No. 23041-2B900	2
G4FJ	1591	4	130-150 KW 177-204 PS	CEE'D 1.6 GT PRO CEE'D 1.6 GT SPORTAGE 1.6 GDI	06/13 - 06/13 - 09/15 -	77,00	71 2410 0000 5000	4 4	STD 0,50	For OE No. 23041-2B600	3

							
<b>1</b>	<b>76,50 mm</b>						
		KH 28,20 VT1 -0,50 VT2 -0,50 MT -3,50 GL 50,20	LOX	L 47,00 Ø 18,00		1,20 910 IF CR S 1,20 931 FE 2,00 777 CR S	
		<b>71 2477 0000</b> <b>5000</b>	For OE No. 23410-26500			79 2477 0000	
<b>2</b>	<b>77,00 mm</b>						
		KH 26,80 GL 45,00	LOX	L 52,50 Ø 18,00		1,20 910 IF NIT S 1,20 931 P 2,00 947 EX NIT S	
		<b>71 2409 0000</b> <b>5000</b>	For OE No. 23041-2B900			79 2409 0000	
<b>3</b>	<b>77,00 mm</b>						
		KH 26,80 BÜ 3,00 GL 48,00	LOX	L 52,50 Ø 18,00		1,20 910 IF NIT S 1,20 931 P 2,00 947 EX NIT S	
		<b>71 2410 0000</b> <b>5000</b>	For OE No. 23041-2B600			79 2409 0000	